

# Salto S5000 Smart Card Comfort Model

salto**systems.com**



- Comfort range: created for internal doors, the most relevant characteristics of which are the management, flexibility, control and above all comfort of the system.
- Designed to cover a wide range of solutions through a unique design.
- PC based access control system.
- High security, by using password and encrypted Chip cards instead of copiable Mag. Stripe.
- Extremely weather resistant.
- Salto Pro Access or Hotel Software intuitive and user friendly. Windows 98, 2000 and XP compatible and available in many languages. In case a certain language is not available, it could be adapted immediately.
- Salto PMS interface available.
- Slim and aesthetic design of the escutcheon itself. No bulky elements. Blends seamlessly with every building decoration.
- Simple and intuitive peripherals.
- Portable Programming Device (PPD) in order to communicate with the offline units.
- Unlimited numbers of Master cards, with enhanced Staff management functions through the power of the Chip Card and Virtual Net possibilities.

**SALTO**  
inspired access

# Salto S5000 Smart Card Comfort Model

inspired access

## Mechanical features

- Tested and approved for 1/2 hour fire rating.
- Escutcheons with electronic blocking system of the outside handle. Access given through Chip Card insertion.
- Inside always allows opening (anti panic in combination with lock).
- Simple off line installation, on any kind of door, including narrow style frames.
- Wire free system.
- Batteries allow autonomy of 3-4 years (30.000 openings).
- Optional with Anti Panic Mortise lock, anti card device, equipped with micro switch.

## Electronic features

- Electronic escutcheon **S 5000**, comfort, Smart.
- Uses a range of ISO smart memory cards.
- Non volatile memory (is not deleted, even without power).
- Electronic privacy option through thumb turn or button on inside escutcheon. This blocks all cards from operating the lock, except management master cards which will always override this privacy mode to gain entry in cases of emergency.
- Escutcheons are equipped with a low consumption real time clock function, which allows time zones access planning and the use of 10 different calendars.

- Dual colour LED (green/red) to indicate lock authorisation. Special blink indication when lock is in privacy mode. Possibility to enable/disable the acoustic signal.
- Low battery indication at the lock and through software (battery status info is written on management Smart Cards).

## All weather features

- Reader drain to eliminate water from the reader.
- Reader gaskets to protect the reader from water entry.
- Back plate gaskets to protect PC Board from water entry.

## Handles

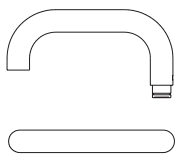

U Model

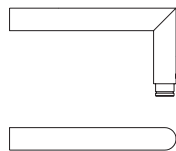

W Model

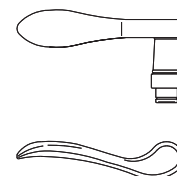

O Model

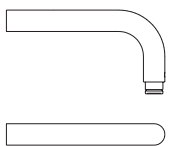

L Model

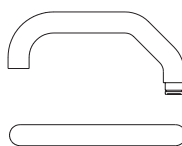

H Model

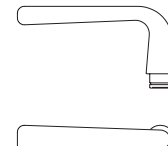

K Model

## Finishes



SATIN/POLISHED  
STAINLESS STEEL



WHITE  
(POWDER COATED)



BLACK  
(POWDER COATED)



POLISHED BRASS



SATIN BRASS



ANTIQUÉ BRASS

U, L, W, H handles available

L, K, O handles available

# Salto S5000 Smart Card Comfort Model

inspired access

## Accessories & Software

- Portable Programming Device (PPD).

A messenger between the door and the PC. It is used to initialize the locks, and allows for emergency opening in case batteries of power failure.

- Smart Card Encoder.

Super fast and compact electronic device which eliminates the need for bulky expensive motorised encoder units. RS232 version or ethernet version.



PPD



Smart Card Encoder

- Pro Access Software.

Extremely intuitive and user friendly, it allows to manage all the features of a full access control system. Main features allow to program in access time zones for each user, take into account different company calendars, obtain audit-trails and it includes special functions like automatic changes of the door status.



Pro Access Software

- Salto Hotel Software.

Extremely intuitive and user friendly for check in staff and includes easy to manage back office screens. The front desk provides at a glance all check-in/out functions. Includes several PMS protocols and ethernet encoder communication menu.



Hotel Software (HAMS)

## Models Range

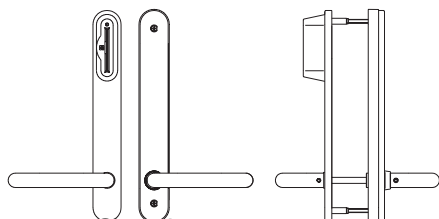

Model S5010  
Electronic Escutcheon  
S5000 Comfort Smart  
2 Handles, any type.

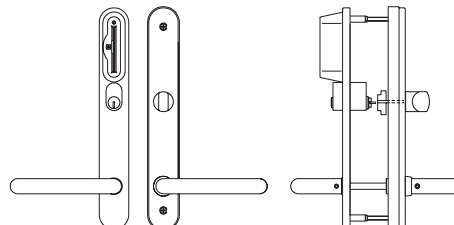

Model S5015  
Electronic Escutcheon  
S5000 Comfort Smart  
2 Handles, any type.  
Outside Cylinder outtake.  
Inside Thumbturn.  
With connector for Mortise Lock  
with Micro-Switch.

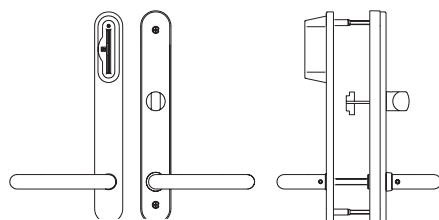

Model S5011  
Electronic Escutcheon  
S5000 Comfort Smart  
2 Handles, any type.  
Inside Thumbturn.  
With connector for Mortise Lock  
with Micro-Switch.

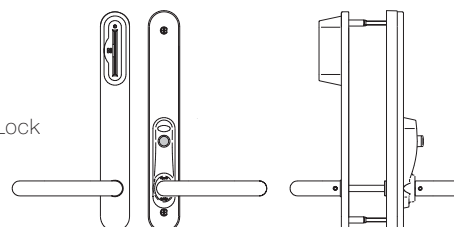

Model S5016  
Electronic Escutcheon  
S5000 Comfort Smart  
2 Handles, any type.  
Electronic "Do not disturb"  
system.

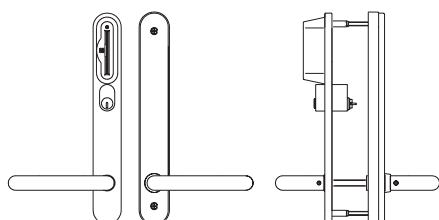

Model S5014  
Electronic Escutcheon  
S5000 Comfort Smart  
2 Handles, any type.  
Outside Cylinder outtake.  
With connector for Mortise Lock  
with Micro-Switch.

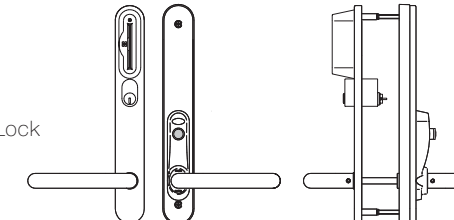

Model S5017  
Electronic Escutcheon  
S5000 Comfort Smart  
2 Handles, any type.  
Electronic "Do not disturb"  
system.  
Outside Cylinder outtake.

# Salto S5000 Smart Card Comfort Model

inspired access

## Technical features

- Up to 64000 users.
- Locking plan up to 64000 doors.
- Audit trail: Storage of 1000 last events in non volatile flash memory.
- Power supply: 3 alkaline batteries LR03 AAA 1,5V.
- Temperature range.
  - external escutcheon: -20° / 70° C.
  - internal escutcheon: 0° / 50° C.
- 1/2 hour fire rating, including according DIN.
- Optional mechanical cylinder override.

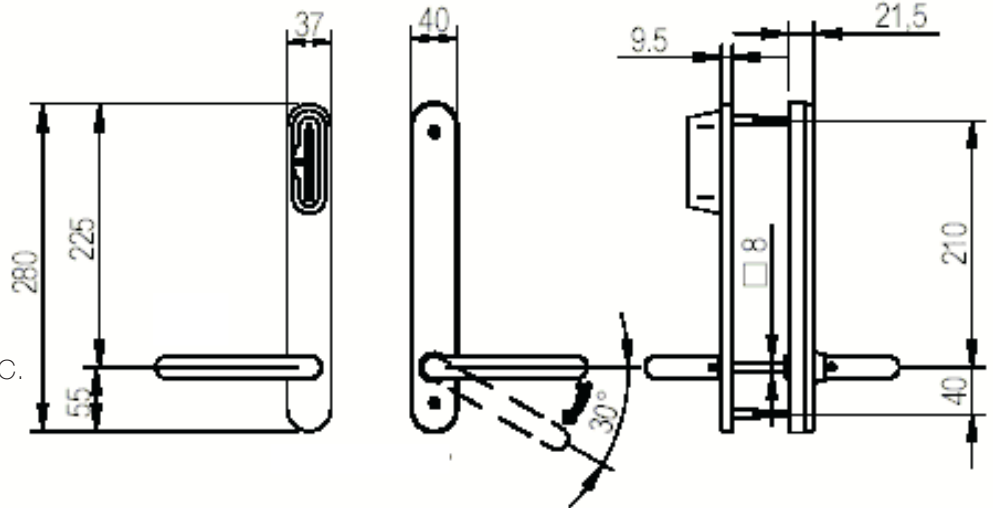

## Available Smart Card Carriers

- 256 Bytes memory Card: Password protected, non copiable.
  - 192 Bytes memory Card: Encrypted, not copiable.
  - 2 Kbytes memory Management Card: High Capacity encrypted, non-copiable management card. Highly suitable for Salto Virtual Network options, like on-card audit trails.
- 
- Building/Hotel logo and publicity can be printed on card.



**SALTO**  
inspired access

SALTO Systems

Txatxamendi, 26 - Pol.110 - 20100 LEZO Gipuzkoa · Tel.: +34 943 344 550 - Fax +34 943 341 621  
e-mail: info@saltosystems.com - [www.saltosystems.com](http://www.saltosystems.com)